



# Elite

PROJECT ENGINEERING

DESIGNERS, ENGINEERS, MANUFACTURER & PROJECT PROCUREMENT SPECIALISTS

Email: [saj@elitegocl.com](mailto:saj@elitegocl.com) [www.elitegocl.com](http://www.elitegocl.com)

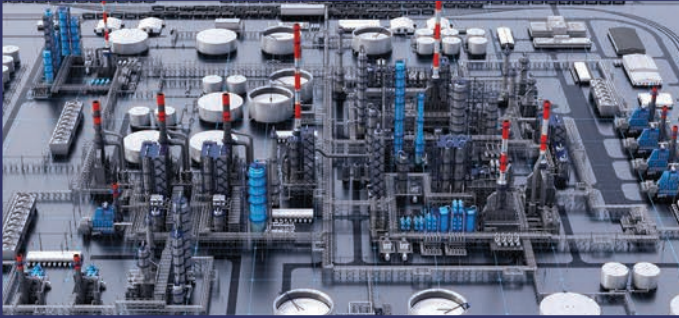

## Profile:

Elite Project Engineering is specialized in Design, Engineering and Procurement services for ;

- Oil and Gas
- Petrochemical
- Chemical
- Fertilizer
- Oil Storage Terminals
- LPG Storage Depots
- Power Plants
- Food Processing
- Sugar Mills
- Pharmaceutical

The company is operating under the supervision of senior management having vast experience in Oil & Gas and Petrochemical sectors having its headquarter in China and global offices in United Kingdom, Unites States of America, Canada, Brazil, United Arab Emirates, Pakistan and Nigeria.

In addition to Design and Engineering services, we are capable to take over the complete Procurement (P) part of an EPCC (Engineering, Procurement and Construction and Commissioning) projects either directly from End Users, in Joint Venture with EPCC Contractor and or from EPC Contractor to make sure seamless supply chain management of all project materials from the stud bolts to the process equipment and from the pipeline to the drilling rig depending on the nature of project either its of Oil & Gas (Exploration, Gas Compression, Gas Processing, LPG Extraction, Oil Refinery, Oil Storage Depot) or Petrochemical, Chemical, Fertilizer, Power Plant, Food Processing, Sugar Mill, Pharmaceutical and / or allied industries.

Elite clients always enjoy the seamless services through our highly professional representatives who are assigned delicately to one project at a time to oversee client contracts, supplier contracts and deliveries.

### **Mission:**

Elite is a leader in providing value-added Design, Engineering and Procurement services by creating a successful partnership with all stakeholders. Elite believe in lasting relationships with all stakeholders by exceeding their expectations and gaining their trust through meticulous performance by every member of the organization with the strong commitment to Quality, Health, Safety and Environment (QHSE).

### **Vision:**

To be the most preferred and trusted partner of our customers in the industry with special focus and emphasis on delivering quality products & services.

### **Core Values:**

**Quality:** It is our primary focus to produce and deliver superior quality products and services.

**Commitment:** What we commit, we deliver.

**Teamwork:** We believe in teamwork, which is the most important element to accomplish the set objective.

**Customer Satisfaction:** To achieve customer satisfaction with Quality, Commitment and Teamwork.





## Basic & Detail Engineering:

An industrial plant-engineering project must be considered alive and evolving from its conceptualization up to its operation start up.

Furthermore, basic mechanical engineering must interpret and ensure client's requirement throughout the project lifecycle and provide an agile and reliable interface with other players of the project (owner, contractors, suppliers).

Engineering works must ease an optimum plant construction stage in technical, delivery time and costs terms, so that an optimal project management, technical accuracy, and error avoidance is a must.

Experience and knowledge, powerful design software tools and total-quality management are the keys on which a successful industrial engineering project is supported. From conceptual early stages to start up and first operation tests, Elite delivers first-class engineering services, including:

### Mechanical Engineering

#### Static Equipment:

- Mechanical Design of entire range of process equipment e.g. Vessel, Heat Exchangers, Distillation Columns, Reactor Cone Roof, Floating Roof and Dome Roof Tanks, Mounted Bullets, Silos, Power Plant Equipment etc...
- Design & Engineering as per international codes e.g. ASME Sec. VIII, Div. 1/2, EEMUA, API 650/620, AD Merckblatter, British Standards etc...
- Design by Finite Element analysis, Stress, Thermal analysis & Fatigue life evaluation
- Fabrication Drawings

#### Rotary Equipment:

- Specifications of Pumps, Compressors and Boilers
- Technical and Commercial bid analysis
- Factory Acceptance test witness
- Inspection Plan
- Vibration Analysis
- Specifications for Package bought outs
- Vendor Document Approvals
- Commissioning Report
- Remaining Life

### Detail Engineering

- 3D integrated model (civil works, equipment, structures, piping)
- Plant Layouts and General Arrangement drawings
- Piping routing and isometric drawings
- Piping stress/flexibility analysis and supporting
- Civil and Steel works design and stress analysis
- MTOs
- Construction procedures
- As-Built drawings
- Purchasing Engineering
- Construction Supervision





## Process Engineering:

Whether object of study or design is focused on equipment, systems or facilities, the fact of counting with a deep process perspective allow Elite to deliver comprehensive technical solutions along the life cycle of industrial assets, where defining and understanding of process requirements is a must.

Elite's process engineering capabilities comprise the following knowledge areas and activities applied on equipment and plant systems:



### Chemical Processes

### Thermodynamic Processes

### Heat Transfer

### Hydraulics

#### Design, Simulation and Optimization of processes

- Distillation
- Gasification
- Esterification
- Combustion
- Downstream
- Spray Drying
- Evaporation
- Thermal Storage
- Water Treatment

#### Basic Engineering

- P&ID
- Data Sheets
- PSVs

#### Heat Transfer and Process Equipment

- Process, Thermal & Hydraulic Design
- Design (by others) review and consultancy
- Performance Assessment

##### Equipment:

- Shell & Tube Heat Exchangers
- Air Cooler Heat Exchangers
- Waste Heat Boilers
- Fired Heaters
- Coil Tanks
- Separators
- Distillation Columns
- Evaporators
- Jacket Tanks
- Deaerators
- Storage Tanks

#### Technical Audits

- Influence of actual operation (corrosion, thermal shocks, thermal ramps)
- Remaining Life Analysis
- Operation Strategies to improve Remaining Life
- Performance Assessment
- RCA – Root Cause Analysis
- Inspection Plans
- Process Review (steam cycle, water treatment, etc.)
- Operation procedures review

##### Critical Equipment

- Boilers
- Heat Exchangers
- Pumps
- Tanks, etc.



## Equipment Engineering:

Elite provides full engineering and design services around heat transfer, process and static equipment, ranging from process specification to detailed drawings and fabrication from approved OEM facilities.

- Bulk Oil Storage Tanks
- LPG Spherical Tanks
- LPG Bullets
- Pressure Vessels
- Pig Launchers / Receivers Traps
- Heat Exchangers
- Customized Process Skids
- Gas Metering Skids
- CFB & HRSG Boilers
- Coal -fired Oil (gas)-fired Boilers
- Reactors
- Columns and Towers

Elite delivers advanced equipment engineering services to equipment suppliers, EPC contractors and Plant Owners.

### Process Data Sheet

- Process Simulation
- Thermal & Hydraulic Design
- TEMA/API
- Basic Engineering
- CFD simulation

### Mechanical Data Sheet

- Mechanical Design (DBF and/or DBA)
- ASME/EN
- FEA/CHT Simulation

### Drawings

- Detailed Drawings valid for constructions
- BOM

### Purchasing Specification

- Owner's Engineering
- Review of technical bids
- Supply Specification

### Technical Approval

- KOM with supplier
- Commissioning
- Supervision of Manufacturing

### Supply and Start Up

- Plant Coordination
- Start-up technical support

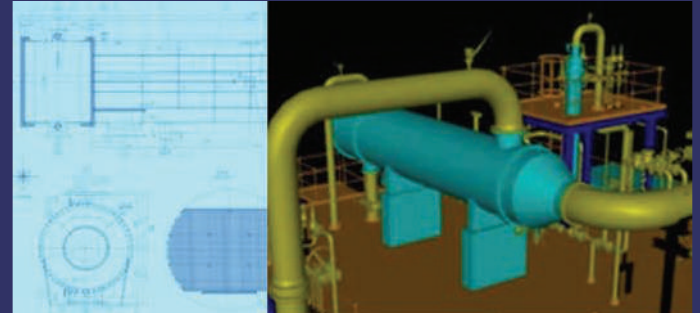



## Civil Engineering:

Elite Civil Engineering services includes:

- Development of facilities and related civil work
- Structural analysis
- Foundation Design for Equipment and Tank
- Structural Design
- Design of Platform top sides
- Engineering of Skids and Modular Structures
- Structural 3-D Modeling
- Automated fabrication drawing and MTO generation
- Under Ground Storage Basin
- Design of Technological Structures for Refinery and Petrochemical Units
- Structural analysis & detail engineering of Fired Heaters and Reformers
- Design of Deepwater Structure

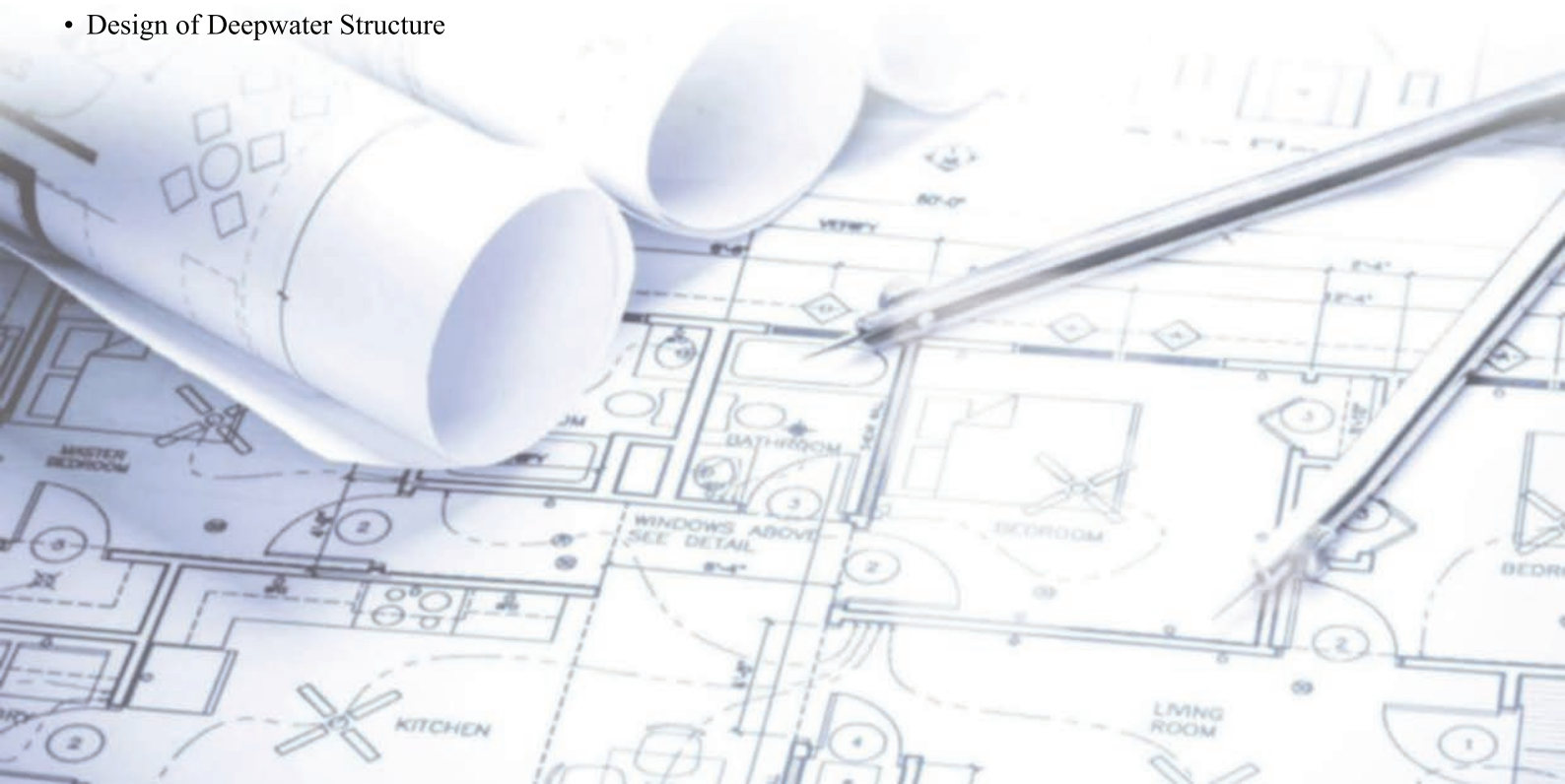

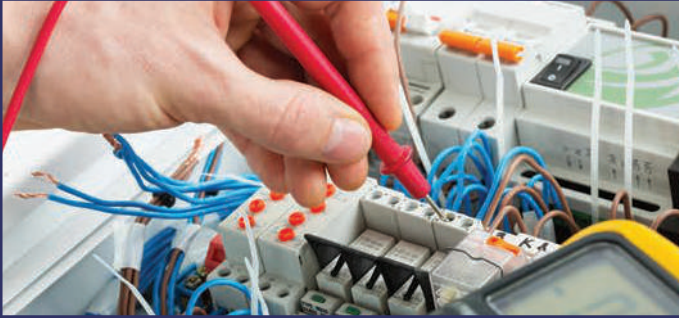

## Electrical Engineering:

- Electrical System Study
- System reliability and stability study
- Substation Design
- Hazardous Area Classification
- Load Calculation and System design
- Specifications for Electrical Equipment
- Calculation of Electrical Bulk Materials
- General Arrangements & Interface inputs
- Estimation of Power requirement and evolving Single Line Diagram for Power Distribution system and Illumination Engineering
- Specifications and schedule of quantities for Electrical Equipment
- Cable Schedules and Termination Schedules
- General Arrangement and Civil Input Data for switchyard Substations, Load Dispatch Centers and Control Rooms
- Short Circuit Study and Relay Setting recommendations
- Preparation of Layouts for Project Execution / Statutory approvals e.g. Equipment layouts, Cable Tray / Trench Layouts, Earthing & Lighting Protection Layouts and Lighting Layouts including Distribution Schedules

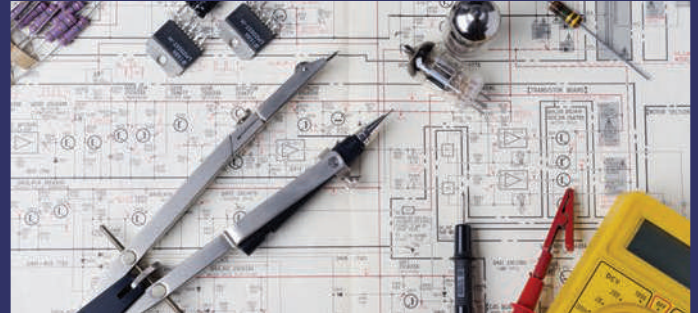

## Instrumentation Engineering:

- Development of Control Logic
- Safety Studies
- Instrument Data Sheets and Index
- Logic Development and preparation of Cause & Effect diagrams
- DCS/PLC engineering & I/O List
- Preparation of Field Instrument and Control Panel Specifications
- Preparation of Interlock diagrams and loop drawings
- Preparation of JB and Cable Schedule
- Layout for Instrument / JB / Cable Trays for Field & Control Room
- Installation, Mounting and hook up drawings
- F&G & PA System
- Preparation of Air and Power distribution scheme
- Control Architecture
- Signal Lists
- Control Loops
- Functional Description
- Line Lists
- Instrument Specs
- Sizing of Relief Valve / Control Valve / Orifice Plate

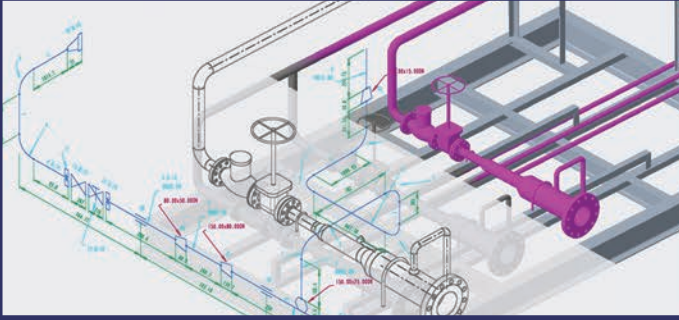

## Piping Engineering:

Piping Design is a critical component of engineering projects and process plants.

The science of piping engineering involves developing efficient piping processes that safely transport fluids and gases across industrial plants. Optimally designed piping system can enhance the use of space, ease its construction, simplify maintenance and accessibility and improve the overall performance of piping systems.

Elite delivers full piping engineering services including:

### 2D / 3D Design:

- Hydraulic design (flow, velocities, pressure drop)
- Piping specification (materials, pipe schedule, rating of elements)
- Insulation. Thermal losses
- 2D/ 3D Piping Routing and modeling
- Piping lists
- Mechanical piping design (thickness calculation) according to ASME B31.1 / B31.3 / EN13480, etc.
- Isometric drawings for construction
- Bill of materials / quantities.
- As-Built design

### Flexibility Analysis

- Piping Flexibility analysis
- Supports design (type and position)
- Buried pipes
- Check of allowable loads on nozzles (pumps, static equipment, etc.) as per WRC-107
- Dynamic analysis (Modal, Harmonic)

### Advanced Piping Flexibility Analysis (Finite Element Analysis)

- Determination of SIF (stress intensification factor) according to B31J for special geometries not covered by ASME B31.1/B31.3
- Great diameter or rectangular ducts/pipes when Eigen Buckling failure mode analysis is required.
- Special transitions pieces (rectangular/ circular)
- Special supports design
- Creep range design/operation
- Cyclic loads. Fatigue analysis

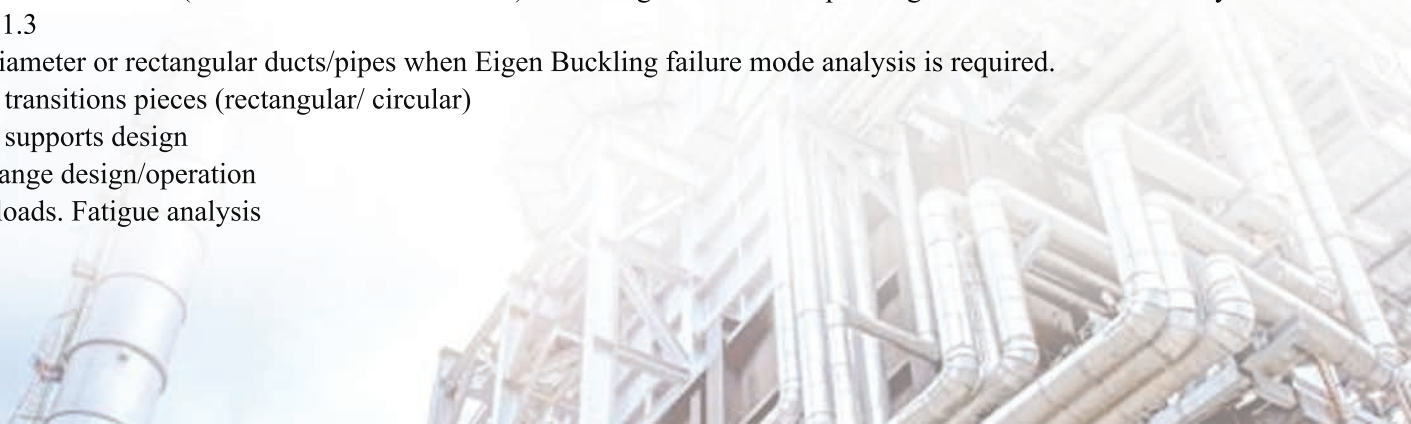
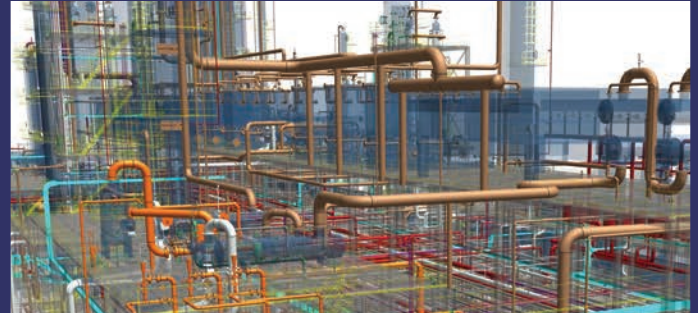





## Inhouse Manufacturing/Fabrication:

Elite has its own production and fabrication facility for

- Ball Valves
- Gate Valves
- Globe Valves
- Check Valves
- Plug Valves
- Butterfly Valves
- PTFE/PFA Lined Valves
- PTFE/PFA Lined Spools, Piping and Equipment
- Pressure Safety Valves (PSVs)
- Air Release Valves
- Fabricated Piping
- Pressure Parts



## Project Procurement:

Elite has extensive experience to deliver Engineering and Procurement part of an EPCC Project while directly working with an EPC Company or with end user.

Our team has vast experience of sourcing process equipment, rotary, machinery, power generation, instrumentation and electrical equipment from global OEM's as per client satisfaction.

Elite's global presence makes it easy to source from most time and cost-effective origins as per client requirement.

The procurement includes but not limited to:

- Process Equipment
- Oilfield Equipment
- Mechanical / Electro-Mechanical Equipment
- Heavy / Earthmoving & Construction Equipment
- Fire Fighting Equipment
- LPG Equipment
- Cathodic Protection
- Electrical & Instrumentation



## Partial Project References:



### Gas Pressure Regulating and Metering Station (PRMS)

Supply, Installation and Commissioning of PRMS including 120 KW Water Heater, EXD control panel and complete piping network at ceramic and porcelain tiles plant.



### Fire Water Pump, Bulk Piping and Valves

Supplied Complete Skid Mounted Fire Water Pump Set Including 2000 GPM Main Pump, Diesel Engine, Jockey Pump, Controller UL/FM approved built according to NFPA 20 rules together with firefighting accessories, Bulk Piping and Valves to Gas Extraction Plant.



## Partial Project References:

### **Pig Launcher and Receiver, Valves, Piping Material, Fire Fighting Equipment/Accessories**

Supplied Pig Launcher and Receiver, Valves, Piping Material, Fire Fighting Equipment / Accessories to Bulk Oil Storage Depot.



### **Hiboil Column Condenser**

Fabricated and Supplied Heat Exchanger (Hiboil Column Condenser) to Chemical Plant.

- Tube Material: SB-111M 061 C1520
- Shell Material: SA-516M Gr.485
- Tube Sheet/Channel Material: SA-266M Gr.2+SB-171M025 C71520 (Integral Cladding)



## Partial Project References:

### Crude EDC Condenser

Fabricated and Supplied Heat Exchanger (Crude EDC Condenser) to Chemical plant.

- Tube Material: SB-677/N0890
- Tube Sheet/Channel Material: SA-240 904L/N08904
- Shell Material: SA-516M Gr.485



### Hiboil Column Vent Chiller

Fabricated and Supplied Heat Exchanger (Hiboil Column Vent Chiller) to Chemical Plant.

- Tube Material: SB-622M N10276
- Tube Sheet / Channel Material: SA350M LF2 CL1+N10276 (Weld Overlay)
- Shell Material: SA-516M Gr.485N



## Partial Project References:

### Boiler Parts

Supplied Boiler Pressure Parts to Oil Refinery.





# Elite

## PROJECT ENGINEERING

Zhejiang Elite Project Engineering Co., Ltd.  
Wenzhou Elite Flow Control Co., Ltd.

**Corporate Headquarter:**

Office No. 903, 9th Floor, Zhonggou International Office Building, Yangguangdadao Street., Oubei Town, Yongjia, Wenzhou, Zhejiang Province, People's Republic of China.  
Tel: +86 (0) 577 66965398  
E mail : [saj@elitegocl.com](mailto:saj@elitegocl.com)

**Elite Flow Control UK Limited**

Unit 1, Winghay Close, Longbridge Hayes Industrial Estate, Stoke-on-Trent, ST6 4DU, Staffordshire, United Kingdom.  
Tel: +44 (0) 1782 978341 / +44 (0) 7465 965031

**Elite Project Engineering (Pvt) Ltd**

B 69, Block 18, KDA Scheme 24, Gulshan Iqbal, Karachi, Pakistan.  
Tel: +92 213 4820542 / +92 (0) 332 3767598

**Manufacturing Facility:**

No. 425, Zhangbao West Road, Dongou Industrial Zone, Oubei Street, Yongjia County, Wenzhou City, Zhejiang Province, People's Republic of China.  
Tel: +86 (0) 577 66965398  
E mail : [saj@elitegocl.com](mailto:saj@elitegocl.com)

**Elite Flow Control USA**

4840 Irvine Blvd Ste 205, Irvine, CA 92620, United States of America.  
Tel: +1 (0) 514 594 1696

**Zhejiang Elite Project Engineering Co., Ltd.**

Suite # 204, 5, Force Road, Lagos Island, Opposite Tafawa Balewa, Lagos Island, Lagos, Nigeria.  
Tel: +234 (0) 915 2248317

E mail : [saj@elitegocl.com](mailto:saj@elitegocl.com) www

